

Important Safety Instruction

Copyright Information

Copyright © 2021 by LAUNCH TECH CO., LTD. All rights reserved. No part of this publication may be reproduced, stored in a retrieval system, or transmitted in any form or by any means, electronic, mechanical, photocopying, recording or otherwise, without the prior written permission of LAUNCH.

Disclaimer of Warranties and Limitation of Liabilities

All information, specifications and illustrations in this publication are based on the latest information available at the time of printing. Launch reserves the right to make changes at any time without prior notice.

Safety Instructions

Before using this test equipment, please read the following safety information carefully.

- Always perform automotive testing in a safe environment.
- Wear an ANSI-approved eye shield when testing or repairing vehicles.
- The vehicle shall be tested in a well-ventilated work area, as engines produce various poisonous compounds (hydrocarbon, carbon monoxide, nitrogen oxides, etc.)
- Do not connect or disconnect any test equipment while the ignition is on or the engine is running.
- Put blocks in front of the drive wheels and never leave the vehicle unattended while testing.
- Do not drive the vehicle and operate the test equipment at the same time. Any distraction may cause an accident.
- Keep clothing, hair, hands, tools, test equipment, etc. away from all moving or hot engine parts.
- Keep a fire extinguisher suitable for chemical, gasoline and electrical fires nearby.
- Before starting the engine, put the gear lever in NEUTRAL (for manual transmission) or PARK (for automatic transmission) to avoid injury.
- To avoid damaging the test equipment or generating false data, please make sure the vehicle battery is fully charged and the connection to the vehicle DLC (Data Link Connector) is clear and secure.
- Automotive batteries contain sulfuric acid that is harmful to skin. In operation, direct contact with the automotive batteries should be avoided. Keep the ignition sources away from the battery at all times.

THANK YOU FOR CHOOSING LAUNCH!

If you have any questions or comments please forward them to:

LAUNCH Tech USA Product Support

Phone: 877-528-6249 xt: 4

Fax: 562-463-1590

1820 S. Milliken Ave. Ontario, CA 91761

Monday - Friday 5 am - 5 pm PST

Service & Repair

Phone: 877-528-6249 xt: 5

Monday - Friday 8 am - 5 pm PST

Please visit our public form @

<http://launch.activeboard.com>

Accessory Checklist

For different product configurations, the accessories may vary. For detailed accessory items, please consult from the local agency or check the packing list supplied with this tool together.



X-431 Throttle III Tablet

A tablet for showing test results.



SmartLink C Device

A VCI device for accessing vehicle data.



Power Adapter

To supply power to the tablet through connection to AC outlet.



Type A to Type B Data Cable

Connects the tablet to the VCI device or add-on module (such as Scope Box).



Type A to Type C USB Cable

Connects the tablet to the PC for data exchange.



HDMI Cable

To mirror the tablet screen onto an external projector or monitor with HD interface.



OBD I Adapter Cable

An adapter cable for connecting non-16 pin connector.



Cigarette Lighter Cable

To supply power to the non-16pin connector via vehicle's cigarette lighter receptacle.



Battery Clamps Cable

To supply power to the non-16pin connector via vehicle's battery.



Private & Confidential Paper

A piece of paper bearing Product S/N and Verification Code, which is required for your VCI activation.



O2-1 Scope Box Kit

(For detailed accessories, please check the package box)

Non-16pin Connector Kit

(Optional, For detailed non-16pin connectors, please check the package box)

X-431 Throttle III

Quick Start Guide

LAUNCH

The Global Leader In Diagnostics

X-431 Throttle III Tablet

The tablet acts as the central processing system, which is used to receive and analyze the live vehicle data from the SmartLink C device and then output the test result.

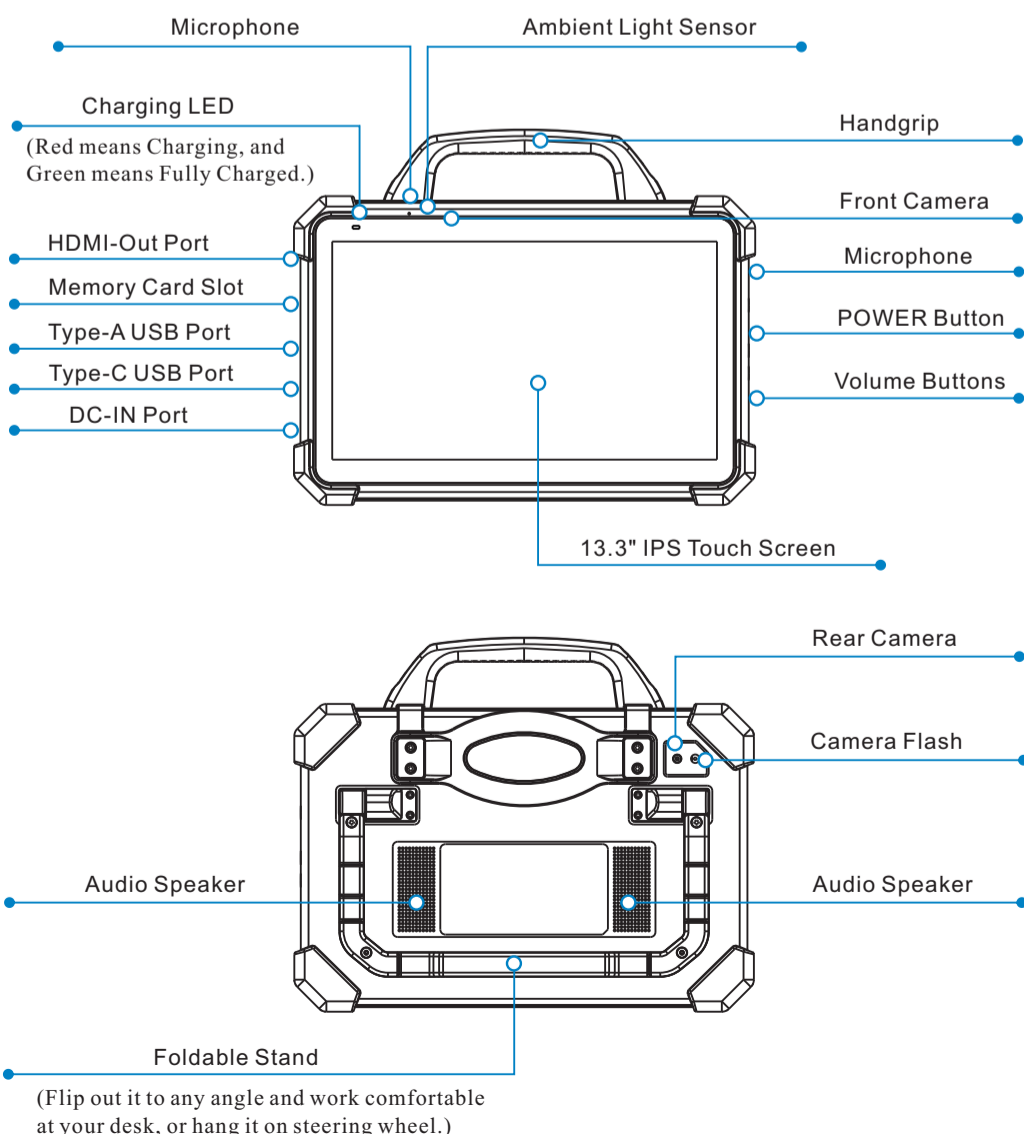

VCI (Vehicle Communication Interface)

The SmartLink C device works as a VCI (Vehicle Communication Interface) device, which is used to obtain vehicle data, and then send it to the tablet for analysis via WiFi / BT / USB communication.

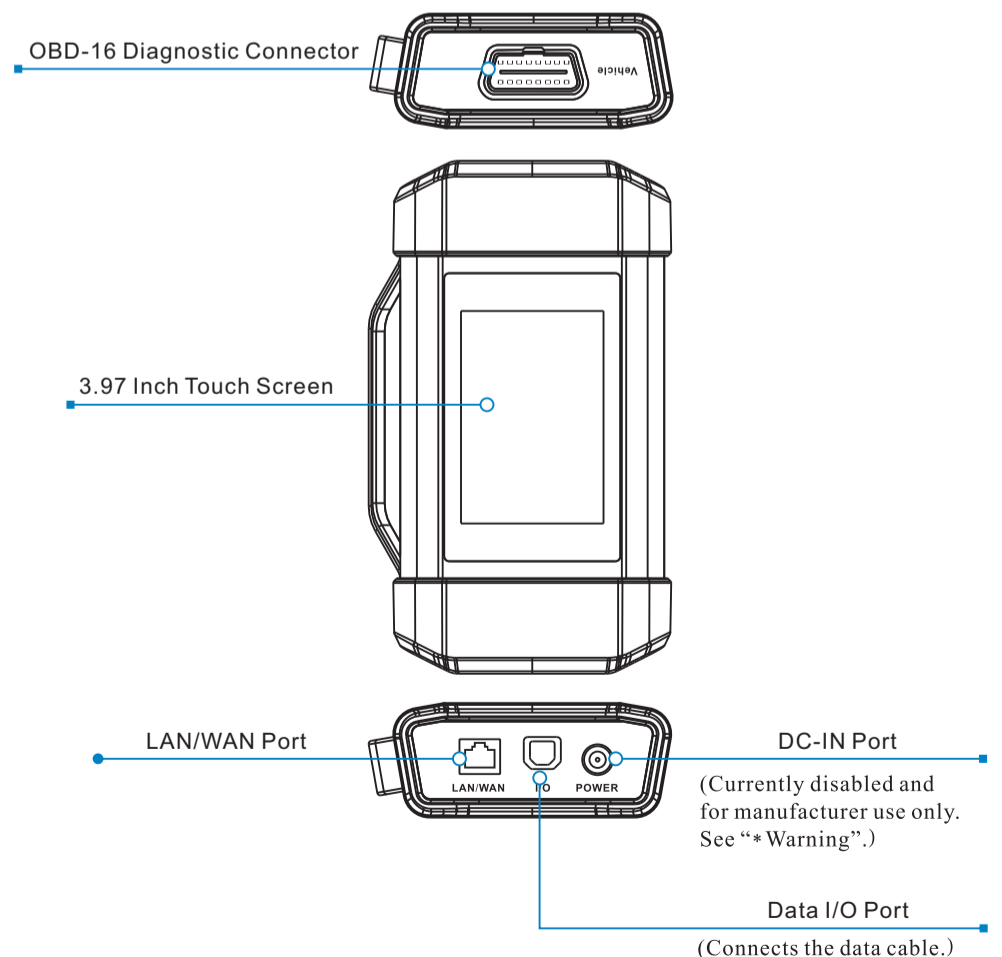

Warning: The SmartLink C device obtains power through the vehicle's DLC port, and it is prohibited to connect to an external DC power supply. No responsibility can be assumed for any damage or loss caused as a result of not strictly following the above method.

1. Charging & Turning On

1. Plug one end of the included power adaptor into the charging port of the handset, and other end into the AC outlet.
2. Once the battery is fully charged, disconnect the power adaptor from the AC outlet.
3. Press the [POWER] button on the handset, the system starts initializing and then enters the home screen.

* If the battery remains unused for a long period of time or the battery is completely discharged, it is normal that the tool will not power on while being charged. Please charge it for a period of 5 minutes and then turn it on. Please use the included power adaptor to charge your tool. No responsibility can be assumed for any damage or loss caused as a result of using power adaptors other than the one supplied.

2. Changing Language

The tablet supports multiple languages. To change the language of the tool,

1. On the home screen, tap on **Settings -> Language & Input -> Languages**.
2. Tap on **"Add a language"**, and then choose the desired language from the list.
3. Tap and hold the desired language and drag it to the top of the screen and then release it, the system will change into the target language.

3. Network Setup

The tablet has dual built-in Wi-Fi communication modules. One is used to communicate with the tablet, and the other allows the tablet to get online. Once you're online, you can register your tool, update diagnostic software & APK, browse the Internet and send email on your network.

If the SmartLink C device is successfully activated, it will be automatically bound to the tablet. In this case it is not necessary for the user to manually configure it again.

1. On the home screen, select **Settings -> Network & Internet -> Wi-Fi**.
2. Select the desired wireless network from the list (Password may be required for secured networks).
3. When **Connected** appears, it indicates that it is properly connected to the network.

4. Register & Update

1. **Launch App:** On the home screen, tap the application icon to launch it, a dialog box similar to the following will pop up on the screen.

- A. If you are a new user, tap on "New Customer" in Fig. A to start your sign-up. Refer to Steps 2-4.
- B. If you have registered to be a member, tap on "Existing Customer" to login the system directly.

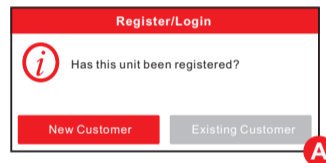

4. Register & Update(Cont.)

2. **Create an App Account:** Tap on "New Registration" in Figure A, input the information (items with * must be filled) and then tap on "Register". Refer to Figure B.

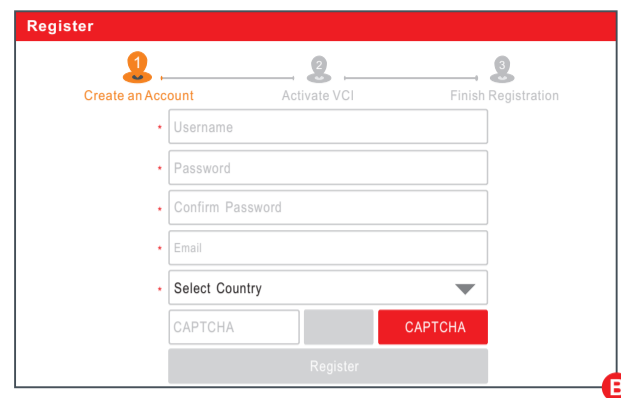

3. **Activate VCI Connector:** Input the Product S/N and Activation Code (can be obtained from the password envelope), and then tap on "Activate". Refer to Figure C.

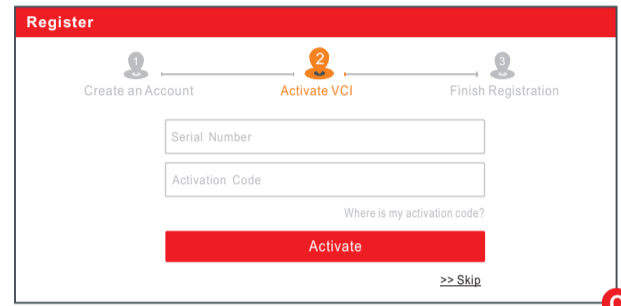

4. **Finish Registration:** To download the diagnostic software, tap on "Yes" to navigate to the download page. Tap on "No" to download and install it later. On the download page, tap on "Update" to start downloading until it is complete.

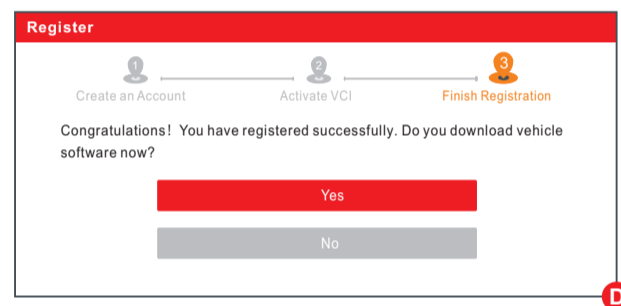

5. Vehicle Connection

The method used to connect the diagnostic connector to a vehicle's DLC (Data Link Connector) depends on the vehicle's configuration as follows:

- A vehicle equipped with an OBD II management system supplies both communication and 12V power through a standardized DLC.
- A vehicle not equipped with an OBD II management system supplies communication through a DLC connection, and in some cases supplies 12V power through the cigarette lighter receptacle or a connection to the vehicle battery.

For passenger vehicles, the DLC is usually located 12 inches from the center of the instrument panel (dash), under or around the driver's side for most vehicles. Below illustrates the possible DLC location.

If the DLC cannot be found, refer to the vehicle's service manual for the location.

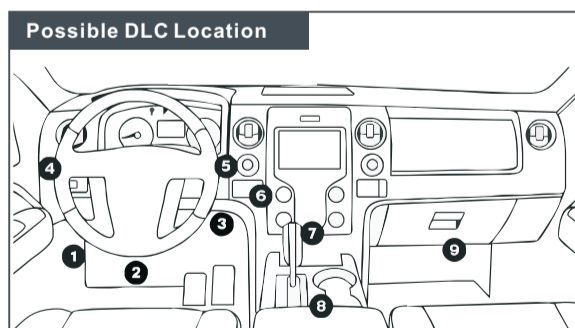

For OBD II vehicles, connect the SmartLink C to vehicle's DLC port directly via the OBD II extension cable.



For non-OBD II vehicles, proceed as follows:

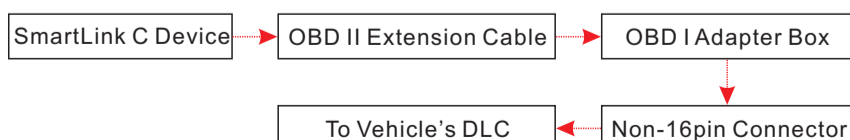

Note: If the power supply on vehicle diagnostic socket is insufficient or the power pin is damaged, you can get power via either of the following ways:

- A. **Via Battery clamps cable:** Connect one end of the battery clamps cable to the power jack of the OBD I adapter box, and the other end to the vehicle's battery.
- B. **Via Cigarette lighter cable:** Connect one end of the cigarette lighter cable to the power jack of the OBD I adapter box, and the other end to the cigarette lighter receptacle.

6. Start Diagnostics

Preparation

Before diagnosing, please make sure the following conditions are met:

- Switch the ignition on.
- Vehicle battery voltage range should be 9-14Volts.
- Throttle should be in a closed position.

Start Diagnostics

This tool supports three kinds of diagnosis approaches: Smart Diagnosis, Remote Diagnosis and Manual Diagnosis.

Smart Diagnosis (AutoDetect):

Through simple wireless (BT) communication between the tablet and VCI device, you can easily get the VIN (Vehicle Identification Number) information of the currently identified vehicle.

Once the VIN is successfully identified, the system will retrieve it from the remote server and then guide you to vehicle information page without the necessity of step-by-step manual menu selection.

Remote Diagnosis (Tech to Tech):

This option aims to help repair shops or professional technicians launch instant messaging and remote diagnosis, making the repair job getting fixed faster.

Manual Diagnosis:

In this mode, you have to diagnose a vehicle by performing the menu-driven command manually.

For new users, please follow the operation chart shown below to get familiar with and start using this tool (*If you choose "AutoDetect" to diagnose a vehicle, this flowchart shall not apply).

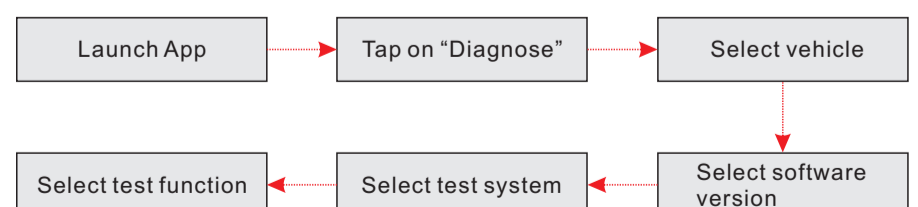

Note: To enjoy more service and functions, you are suggested to check for updates on a frequent basis and keep synchronized with the latest available software.

Statement: LAUNCH owns the complete intellectual property rights for the software used by this product. For any reverse engineering or cracking actions against the software, LAUNCH will block the use of this product and reserve the right to pursue their legal liabilities.